

**AMETEK®**  
PATRIOT SENSORS

**Gemco™**  
Rotary Limit Switches

worm gear type

## SUPERIOR DESIGN AND OPERATING FEATURES

### Heavy-Duty, Shock Resistant FIBRALLOY® Case ...

- resists shocks, acids, alcohol, etc.
- withstands more punishment than die cast enclosures.

### Self-Lubricating Bearings

Powdered metal impregnated bearings for life-time lubrication.

### Gear Ratio Selection

- Eighteen standard gear ratios — 5:1 to 5333.3:1.

### "1/2" Input Shaft

- Ample extension for direct, chain, or gear drive.
- Includes Woodruff Key for quick drive connections.

### External mounting holes ....

- permit mounting without removing the cover and interfering with electrical connections.

### Positive, Independent Cam settings

- Cams adjusted independently of each other.
- Allen Wrench supplied for adjustment.

### U.L. Listed — Snap Action Switches

- Both switches have single pole double throw contacts for versatility of control circuits.

### Cantilever Main Gear Hub

- Bronze gear and steel cams are ...
- mounted on common cam block.
  - supported on a sturdy shaft.
  - requires no support in cover.

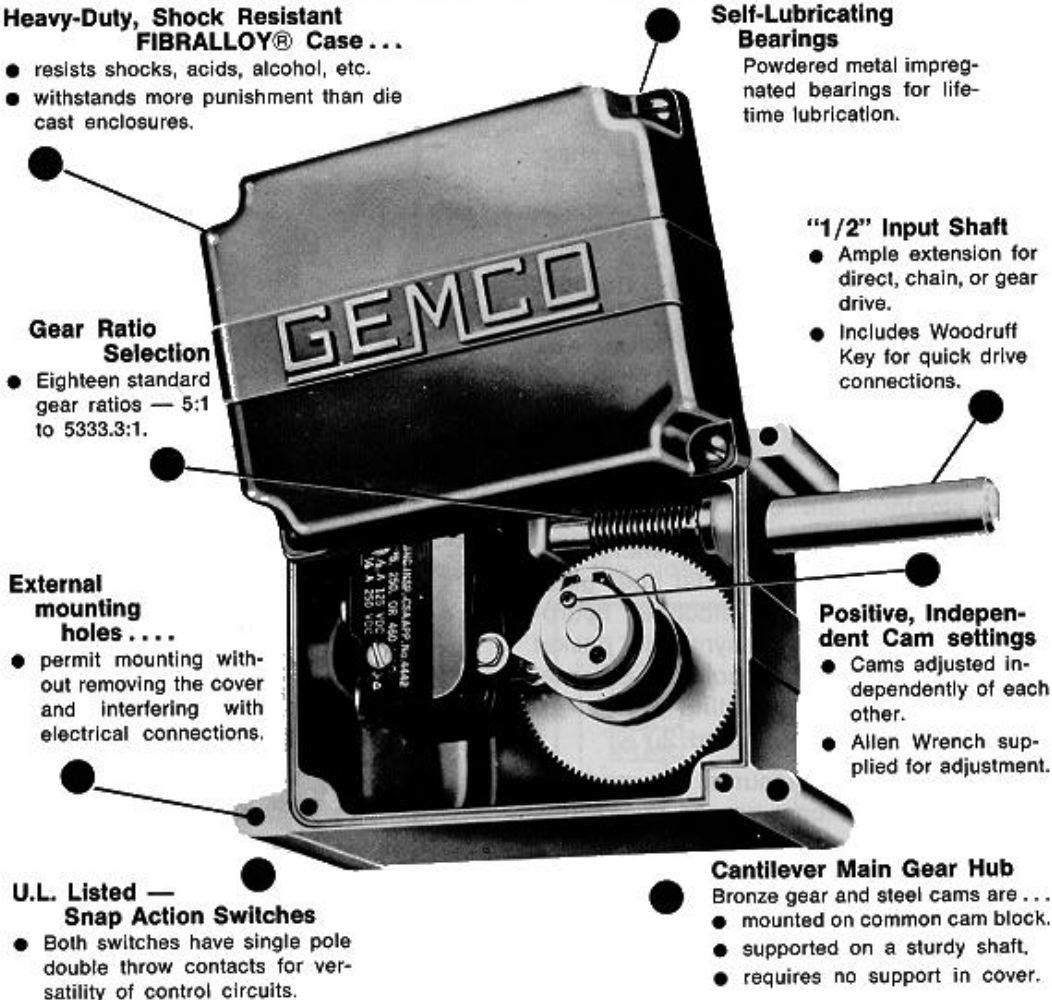

**Application**

**Gemco's** Rotary Limit Switches are primarily used for machine tools, handling devices, and rotary operators where motion is expressed in shaft rotation. The primary purpose of the switch is to control the intermediate or end limits of a linear or rotary motion. The switch is often used as a safety device to protect against accidental damage to equipment.

**Description**

Quality parts make each Rotary Limit Switch highly dependable.

- The 1/2" input shaft (includes Woodruff Key) drives a bronze gear which rotates the cam block. The cam block houses independently adjustable cams that actuate the precision type snap action switches.
- Each switch can be provided with one to four single pole, double throw switches or a maximum of two double pole, double throw switches for versatility of control circuits.
- No minimum speed is specified because snap action contacts are used. Maximum rated speed of the worm shaft is 1000 RPM and can be rotated clockwise or counterclockwise.
- Gemco's Rotary Limit Switch offers the broadest range of standard gear selections of any switch available. Standard ratios range from 5:1 through 5333.3:1.
- Max. Operating Temperature 180°F

**Enclosures**

NEMA Type 1 and 12 (General Purpose) enclosures are molded from FIBRALLOY® a special fiber glass material that is resistant to acids, alcohols, hydro carbons and heat. A tight fitting synthetic gasket prevents the entrance of oil and coolants. External mounting holes enable switch mounting without internal interference. (See Figures 1 and 2.)

NEMA Type 4 (Watertight) enclosures are made of cast aluminum; cast iron or cast bronze enclosures can be provided upon request.

NEMA Type 7 & 9 (Hazardous Location) enclosures are designed to meet the requirements of the National Electrical Code for Class 1, Group D, and Class 2.

Groups E, F & G. The enclosures are made of cast aluminum; cast iron or bronze enclosures can be provided upon request. (See Figure 3.)

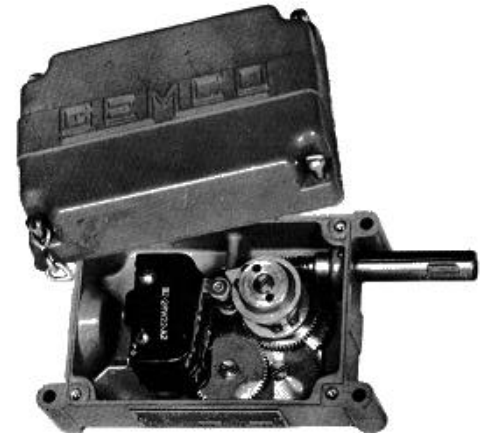

**Figure 1 NEMA 1 Enclosure  
2 circuit**



**Figure 2 NEMA 1 Enclosure  
4 circuit**

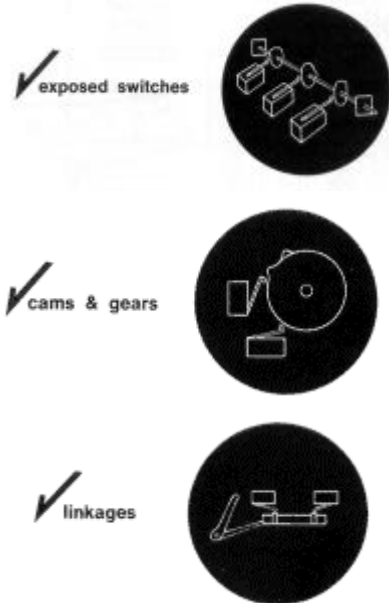

**Figure 3 NEMA 7 Enclosure  
2 circuit**

**check these advantages.... worm gear type**

The GEMCO Rotary Limit Switch

- reduces hazards to inexperienced users.
- removes danger of terminal shorting from water, corrosion, or accidental shorting from other metal objects because of its insulating properties.
- enclosures are made of FIBRALLOY® -- an electrical insulator.

The GEMCO Rotary Limit Switch.

- reduces design time.
- reduces machine work on special cams and gears for different operating ratios.
- cams are all standard regardless of ratios.
- offers special cams upon request.

The GEMCO Rotary Limit Switch.

- often pays for itself by eliminating cost of stampings and machined bushings in linkages.
- reduces assembly time.

**Mounting**

The switch may be mounted in any convenient position. An "L" shaped mounting bracket which permits innumerable mounting positions for all enclosures, can be supplied upon request.

**Adjustment**

- Front cam "A" actuates switch "F"; rear cam "0" actuates switch "E".
- Both switches "E" and "F" have independent adjustable cams.
- To adjust cam "A" loosen Allen Screw "B".
- To adjust cam "0" loosen Allen Screw "C".

When the cam rotates, the switches "E" and "F" are actuated and the contacts change from the normally closed to open position and normally open to the closed position.

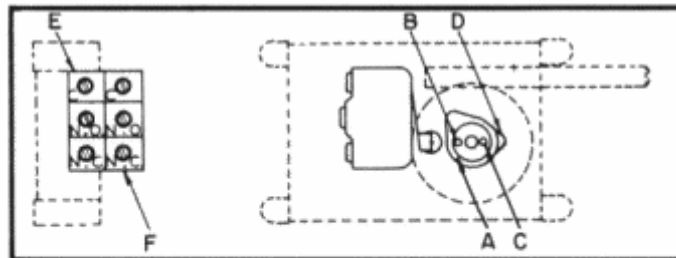
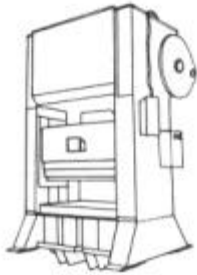

Figure 4 Diagram showing:

- independent adjustable cams A-D
- switches E-F
- Allen Screws B-C

.....plus a broad range of application



✓ mechanical presses

Both die and press, worth thousands the cost of the Gemco Rotary Limit Switch, are safely protected when the connecting rod length is adjusted.

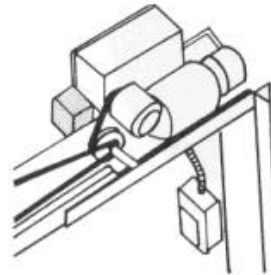

✓ door operators

The Gemco Rotary Limit Switch is mounted on the drive unit, with gear take-off from the main drive shaft. Much wiring is eliminated. Cam accuracy maintains door closing to practical limits.

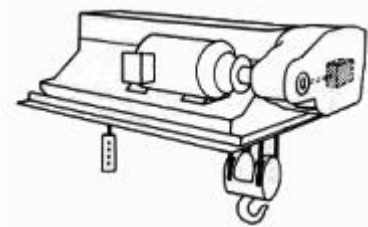

✓ hoists

Gemco switches on this line of hoists protect power unit from damage by controlling critical upper and lower limit.



<p>✓ loaders</p> <p>You can control travel of pushers, grabs, and other reciprocating parts handlers directly from drive shafts.</p>	<p>✓ valves</p> <p>One or more open and close limits on pipe line, pumping station and machinery valves are accurately controlled with Gemco Rotary Limit Switches.</p>	<p>✓ handling fixtures</p> <p>Assures accurate movement and placement of parts, plus control of mechanical clamping in welding, induction heating or machining fixtures.</p>	<p>✓ windows</p> <p>Gemco Rotary Limit Switches are used for window operators in skylights and monitors, for central station control.</p>

- ✓ motor operated valves
- ✓ packaging machinery
- ✓ tapping heads
- ✓ elevating mechanisms

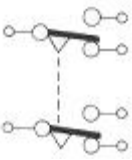
- ✓ pipe threading machines
- ✓ index tables
- ✓ transformer tap changers
- ✓ conveyors

	Input Shaft Rev.	Cam Block Rev.	NEMA 1* & 12 Encl.	NEMA 4 Encl. (1)	NEMA 7 Encl. (1)	Input Shaft Turns****	
			Catalog No.	Catalog No.	Catalog No.	Max. Setting	To Reset
<p><b>Standard Two Cam S.P.D.T.*</b></p> <p>Contact Symbol For Each Cam</p>  <p>Deduct \$12.00 list if One Switch is Omitted.</p>	5	1	2000-1B	2000-98	2000-17B	4 1/2	1/16
	10		2000-38B	2000-39B	2000-40B	9 1/4	18
	20		2000-2B	2000-10B	2000-18B	18	1/8
	30	1	2000-3B	2000-11B	2000-198	28	1/4
	40		2000-4B	2000-12B	2000-20B	37	1/4
	50		2000-5B	2000-13B	2000-21B	46	1/4
	60	1	2000-6B	2000-14B	2000-22B	58	1 1/2
	80		2000-7B	2000-15B	2000-23B	77	3/4
	100		2000-8B	2000-16B	2000-24B	94	3/4
	150	1	2000-129B	2000-132B	2000-135B	135	4
	250		2000-28B	2000-31B	2000-34B	230	6
	300		2000-130B	2000-133B	2000-136B	265	6 1/2
	500	1	2000-29B	2000-32B	2000-35B	460	15 1/4
	600		2000-131B	2000-134B	2000-43B	555	16
	1000		2000-30B	2000-33B	2000-36B	920	29
2000	1	2000-292B	2000-299B	2000-291B	Consult Factory		
4000		2000-279B	2000-127B	2000-128B			
53333		2000-281B	2000-157B	2000-158B			
	Input Shaft Rev.	Cam Block Rev.	NEMA 1* & 12 Encl.	NEMA 4 Encl. (1)	NEMA 7 Encl. (1)	Input Shaft Turns****	
			Catalog No.	Catalog No.	Catalog No.	Max. Setting	To Reset
<p><b>Standard Two Cam D.P.D.T.**</b></p> <p>Contact Symbol For Each Cam</p> 	5	1	2000-137B	2000-145B	2000-159B	4 3/4	1/8
	10		2000-138B	2000-146B	2000-160B	9 1/4	1/4
	20		2000-25B	2000-147B	2000-161B	19	1/2
	30	1	2000-47B	2000-148B	2000-60B	28 1/2	1/2
	40		2000-139B	2000-149B	2000-1628	37 3/4	3/4
	50		2000-73B	2000-1508	2000-163B	46 3/4	3/4
	60	1	2000-75B	2000-151B	2000-164B	58	1 1/2
	80		2000-77B	2000-152B	2000-165B	75	1 3/4
	100		2000-43B	2000-153B	2000-166B	95	2
	150	1	2000-1130B	2000-1131B	2000-1132B	135	4
	250		2000-140B	2000-154B	2000-167B	237	6
	300		2000-1133B	2000-1134B	2000-1135B	265	61 1/2
	500	1	2000-141B	2000-155B	2000-168B	460	15 1/4
	600		2000-1136B	2000-1137B	2000-1138B	555	16
	1000		2000-142B	2000-156B	2000-169B	920	29
2000	1	2000-1139B	2000-1140B	2000-1141B	Consult Factory		
4000		2000-1142B	2000-1143B	2000-1144B			
5333.3		2000-1145B	2000-1146B	2000-1147B			

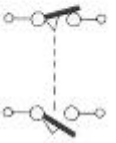

Standard Three Cam S.P.D.T.*** Contact Symbol For Each Cam	Input Shaft Rev.	Cam Block Rev.	NEMA 1* & 12 Encl.	NEMA 4 Encl. (1)	NEMA 7 Encl. (1)	Input Shaft Turns****		
			Catalog No.	Catalog No.	Catalog No.	Max. Setting	To Reset	
	5	1	2000-174B	2000-188B	2000-263B	4 3/4	1/16	
	10		2000-175B	2000-189B	2000-264B	9 1/2	116	
	20		2000-176B	2000-190B	2000-265B	19 1/4	1/8	
	30	1	2000 177B	2000-191B	2000-266B	28 1/2	1/4	
	40		2000 178B	2000 192B	2000 267B	38	1/2	
			2000 179B	2000 193B	2000 268B	47	1/2	
	60	1	2000-180B	2000-194B	2000-269B	57 12	12	
	80		2000-181B	2000-195B	2000-270B	76 3/4	12	
	100		2000-182B	2000-196B	2000-271B	96 1/4	1 12	
	150	1	2000-170B	2000-171B	2000-186B	135	4	
	250		2000-183B	2000-197B	2000-272B	234	2	
	300		2000-187B	2000-300B	2000-301B	265	6 1/2	
	500	1	2000 184B	2000 198B	2000 273B	460	7	
	600		2000-1100B	2000-1101B	2000-1102B	555	16	
1000		2000-185B	2000-199B	2000-274B	920	10		
2000	1	2000-1103B	2000-104B	2000-1105B	Consult Factory			
4000		2000-1106B	2000-1107B	2000-1108B				
5333.3		2000-1109B	2000-1110B	2000-1111B				
Standard Four Cam S.P.D.T.*** Contact Symbol For Each Cam	Input Shaft Rev.	Cam Block Rev.	NEMA 1* & 12 Encl.	NEMA 4 Encl. (1)	NEMA 7 Encl. (1)	Input Shaft Turns****		
			Catalog No.	Catalog No.	Catalog No.	Max. Setting	To Reset	
		5	1	2000-89B	2000-101B	2000-113B	434	1/16
		10		2000-90B	2000-102B	2000-114B	9 12	1/16
		20		2000-91B	2000-103B	2000-115B	19 14	18
		30	1	2000-92B	2000-104B	2000-1 1 6B	28 1/2	1
		40		2000-93B	2000-105B	2000-117B	36	12
		50		2000 94B	2000 106B	2000-118B	47	1 2
		60	1	2000-95B	2000-107B	2000-119B	57 1/2	1/2
		80		2000-96B	2000-1 088	2000-1 20B	76 3/4	1/2
		100		2000-97B	2000-109B	2000-121B	96 1/4	1 1/2
		150	1	2000-1112B	2000-1113B	2000-1114B	135	4
		250		2000-98B	2000-110B	2000-122B	234	2
		300		2000-1115B	2000-1116B	2000-1117B	265	61/2
500		1	2000-99B	2000-111B	2000-123B	460	7	
600			2000-1118B	2000-1119B	2000-1120B	555	16	
1000		2000-100B	2000-112B	2000-124B	920	10		
2000	1	2000-1121B	2000-1122B	2000-1123B	Consult Factory			
4000		2000-1124B	2000-1125B	2000-1 126B				
5333.3		2000-1127B	2000-1128B	2000-1129B				

\*Switch capacities: 125V. - 15 amps. AC., 1/2 amp. D.C.  
15 amps. AC., 1/4 amp. D.C.  
460V. 15 amps. AC.

\*\*Switch capacities: 125 or 250V. AC. - 10 amps.  
125V. D.C. - 1/2 amp.  
250V. D.C. - 1/4 amp.

\*\*\*Switch capacities: 250V.  
Mechanical rating - 20 million cycles  
Electrical rating - 125V. AC. - 10 amps. resistive load.  
250V. AC. - 10 amps. resistive load  
30V. D.C. - 7 amps. inductive load

\*\*\*\*Figures are based on a switch using a standard 25' cam:  
maximum setting between limits.

(1) — For Cast Iron or Bronze Enclosure Contact Factory.

# Special Cams\*

Cam** Part No.	Period for which switch contacts are opened or closed
S-55-A Standard	25° or 335°
S-68-A Special	540° or 306°
S-84-A Special	75° or 285°
S-69-A Special	90° or 270°
S-85-A Special	105° or 255°
S-86-A Special	135° or 225°
S-87-A Special	150° or 210°
S-70-A Special	180°
S-71-A Special	240° or 120°
S-127-A Special	360° Blank Cam

\*Special cams not listed, can be furnished on special order. When ordering, please specify cam angle.

## Ordering

When ordering desired switch, specify:

1. Catalog Number
2. Number of Cams
3. Desired Gear Ratio
4. Type of Enclosure

Example: If a four circuit standard enclosure, 5:1, is required with four 900 cams, order Catalog No. 2000-89 with four Part No. S-69-A Cams. See Special Cam Chart above.

In selecting a gear ratio, maximum accuracy and ease of adjustment are more easily obtained if full travel of drive equals, or is less than maximum setting between limits.

Example: If 90 revolutions of a window drive opens a window, a gear ratio of 100:1 should be selected.

## Design Service

Gemco Design Engineers will be pleased to assist in the solution of any special control problems and to recommend the most suitable Gemco Rotary Limit Switch for your needs. Custom designed switches are available to specifications.

## WORM GEAR TYPE — NEMA 1 & 12

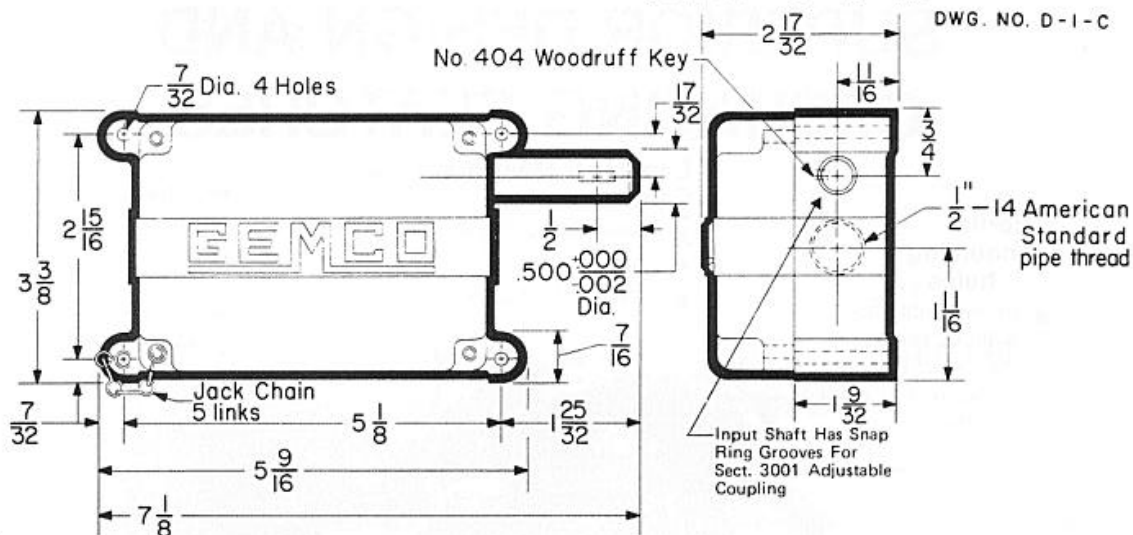

**NOTE** —

Approximate dimensions — not for construction unless certified.

Approximate shipping weight 2 lbs.

## WORM GEAR TYPE — NEMA 4 & 7

DWG. NO. D-16-C (NEMA 4)

D-10-C (NEMA 7)

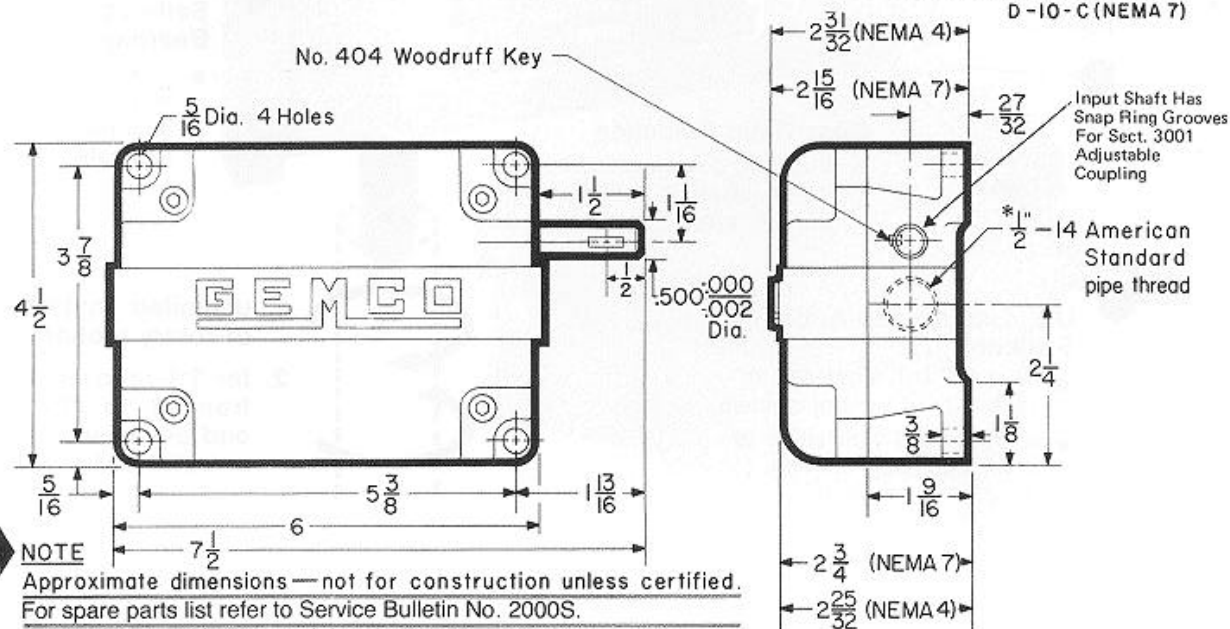

**NOTE**

Approximate dimensions — not for construction unless certified.

For spare parts list refer to Service Bulletin No. 2000S.

Approximate shipping weight 4 1/4 lbs.

\* 1/2" conduit hole can be drilled on either side or bottom.



# Superior Design and Operating Features

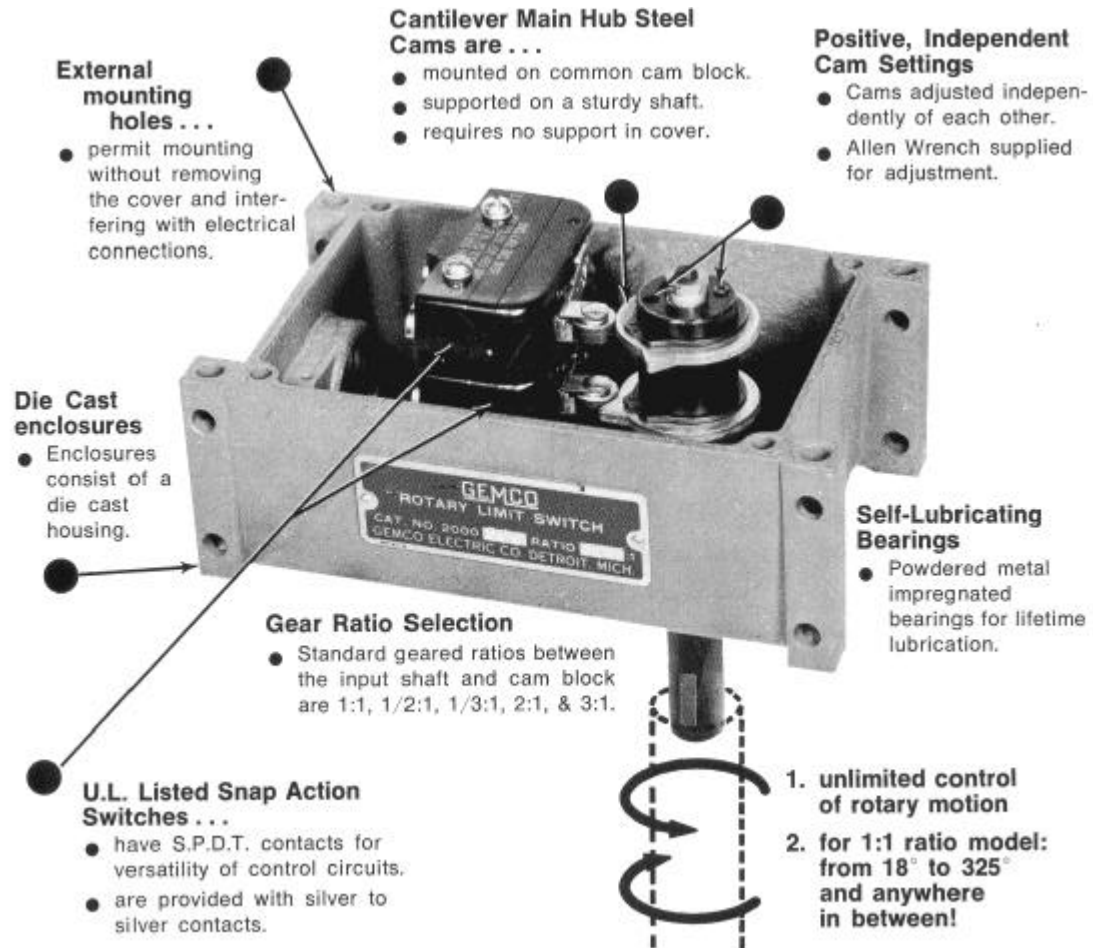

# Rotary Limit Switches

## Application

**GEMCO's** Spur Gear Type Rotary Limit Switch is used in applications requiring ratios below 3:1 and 1:3 for controlling the end and/or intermediate limits of reciprocating or rotary motion. This device extends the present line of Gemco Rotary Limit Switches by providing ultra-sensitive control for small increments of motion.

### Many beneficial features include:

- Control of motor-operated valves, dampers and hopper gates used in pipe lines, ventilating equipment and material handling systems.
- Improved environmental conditions for longer switch life.
- Smaller space requirements.
- Material and labor savings of reduced drilling, tapping, piping, and wiring.
- Economies afforded when Gemco units are applied for many short travel end limit uses instead of conventional lever operated limit switches actuated by cams or dogs.
- Unique mounting which permit these switches to be installed in convenient mounting positions. Mounting holes are provided for either direct or sprocket drive applications in three different positions.

## Description

The basic switch units are actuated by independently adjustable cams which are driven by the input shaft. All cams are mounted on a common block, which is directly coupled or geared to the drive shaft.

### • Ratios

Standard geared ratios between the input shaft and cam block are 1:1, 1/2:1, 1/3:1, 2:1, and 3:1. The 1:1 ratio may be supplied with a potentiometer gear coupled to the input shaft with ratios of 1:1, 1:2 and 1:3.

## spur gear type

### • Long Life Switches

Each enclosure can accommodate from two to four S.P.D.T. switches. All switches are provided with silver to silver contacts for reliability along with screw type terminals,

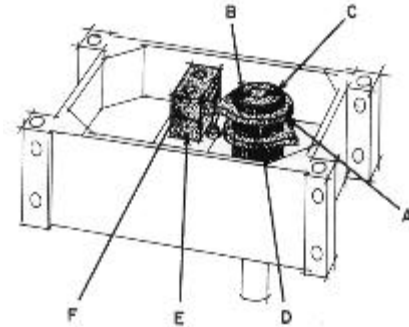

Figure 5 Sketch showing:

- independent adjustable cams A-D
- switches E-F
- Allen screws B-C for cam adjustment

### Mounting

Unique mounting features permit these switches to be installed in any of three different positions. Mounting holes are provided for either direct or sprocket drive applications.

### Adjustment

- Top cam 'A' actuates switch 'F'; bottom cam 'D' actuates switch 'E'.
- Adjustment of cam 'A' is independent of cam 'D'.
- To adjust cam 'A', loosen cam locking screw 'C' and rotate cam 'A' until trip point of switch 'F' is reached.
- To adjust cam 'D', loosen cam locking screw 'B' and rotate cam 'D' until trip point of switch 'E' is reached.

When the cams rotate, the switches are actuated and the contacts change from the normally closed to open position. (See Figure 5.)

# Rotary Limit Switches

## spur gear type

### Enclosures

NEMA Type 1 and 12 (General Purpose) enclosures consist of a die cast housing and **FIBRALLOY®** cover. All mounting holes are external to the wiring cavity eliminating interference with internal wiring when the switch is mounted. Captive screws fasten the cover to the die cast housing and eliminate problems of misplaced screws. (See Figure 6.)

NEMA 4 and 7 enclosures are constructed of aluminum to prevent corrosion. The NEMA 7 (Hazardous Location) enclosure is available for use in Class 1, Group D, areas as outlined in the National Electrical Code. Cast iron enclosures can also be provided on special request. All units are provided with an attractive red wrinkle finish. (See Figure 7.)

### Potentiometer

An optional salient feature of mounting a 2 watt potentiometer within the enclosure, and gear coupled to the input shaft, is offered. This feature permits the potentiometer to be used as a remote position indicator or as a constant output auxiliary control device for open or closed loop feedback systems. (See Figure 8.)

- Step-up geared ratios between the input shaft and the potentiometer are available to provide a choice of sensitivity and resolution to meet most applications.
- The special type potentiometer allows continuous rotation of the drive and a zero or reference point to be adjusted without removing any gears or components.

## SG Type....

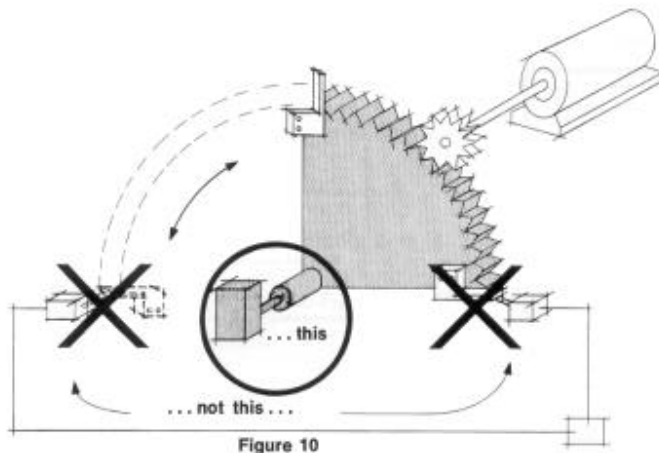

Figure 6 NEMA 1 Enclosure  
2 circuit



Figure 7 NEMA 7 Enclosure  
2 circuit



Figure 8 NEMA 1 Enclosure  
4 circuit with Gear Coupled  
Potentiometer

## ....Rotary Application

### • reciprocating motions

Assures accurate movement and placement of parts in all types of handling and positioning fixtures.

**NOTE** - Replaces two limit switches and electrical piping.

## spur gear type - ROTARY LIMIT SWITCH

Enclosure Type	Input Shaft Rev.	Cam Block Rev.	Two Circuit S. P. D. T. Symbol A	Two Circuit D. P. D. T. Symbol B	Three Circuit S. P. D. T. Symbol C	Four Circuit S.P. D. T. Symbol C
			Catalog Number	Catalog Number	Catalog Number	Catalog Number
<b>NEMA 1 &amp; 12</b>	1	1	2000-800	2000-805	2000-810	2000-815
	1/2	1	2000-801	2000-806	2000-811	2000-816
	1/3	1	2000-802	2000-807	2000-812	2000-817
	2	1	2000-803	2000-808	2000-813	2000-818
	3	1	2000-804	2000-809	2000-814	2000-819
<b>NEMA 4</b>  (1)	1	1	2000-832	2000-837	2000-842	2000-847
	1/2	1	2000-833	2000-838	2000-843	2000-848
	1/3	1	2000-834	2000-839	2000-844	2000-849
	2	1	2000-835	2000-840	2000-845	2000-850
	3	1	2000-836	2000-841	2000-846	2000-851
<b>NEMA 7</b>  (1)	1	1	2000-864	2000-869	2000-874	2000-879
	1/2	1	2000-865	2000-870	2000-875	2000-880
	1/3	1	2000-866	2000-871	2000-876	2000-881
	2	1	2000-867	2000-872	2000-877	2000-882
	3	1	2000-868	2000-873	2000-878	2000-883

## ROTARY LIMIT SWITCH WITH POTENTIOMETER

Enclosure Type	Input Shaft Rev.	Cam Block Rev.	Pot. Rev.	Two Circuit S. P. D. T. Symbol A	Two Circuit D. P. D. T. Symbol B	Three Circuit S. P. D. T. Symbol C	Four Circuit S. P. D. T. Symbol C
				Catalog Number	Catalog Number	Catalog Number	Catalog Number
<b>NEMA 1 &amp; 12</b>	1	1	1	2000-820	2000-823	2000-826	2000-829
	1	1	2	2000-821	2000-824	2000-827	2000-830
	1	1	3	2000-822	2000-825	2000-828	2000-831
<b>NEMA 4</b>	1	1	1	2000-852	2000-855	2000-858	2000-861
	1	1	2	2000-853	2000-856	2000-859	2000-862
	1	1	3	2000-854	2000-857	2000-860	2000-863
<b>NEMA 7</b>	1	1	1	2000-884	2000-887	2000-890	2000-893
	1	1	2	2000-885	2000-888	2000-891	2000-894
	1	1	3	2000-886	2000-889	2000-892	2000-895

(1) Contact Factory for Cast Iron or Bronze Enclosure.

**Ordering**

When ordering desired switch, specify:

1. Catalog Number
2. Quantity Required
3. Desired Gear Ratio
4. Resistance of Potentiometer(if used)

**Potentiometer**

Potentiometers can be provided with resistance of 1, 2, 5, 10, 20, 50, 100, 200, 500, 1000, 2000, 5000, 10,000, or 20,000 ohms. All potentiometers are rated at 2 watts. (Linear taper).

**Gear Ratio Selection**



In selecting a gear ratio, maximum accuracy and ease of adjustment are more easily obtained if rotation of input shaft between limits is equal to, or less than, maximum settings between limits. For example, if .8 revolutions of the input shaft is required to open and close a valve, a gear ratio of 1:1 input to cam should be selected.

**TABLE 1 - engineering data**

Input Shaft Rev.	Cam Block Rev.	TURNS OF INPUT SHAFT *		
		Max. Setting Between Limits	Min. Setting Between Limits	To Reset
1	1	0.9	0.05	0.025
1/2	1	0.45	0.025	0.012
1/3	1	0.30	0.016	0.008
2	1	1.8	0.1	0.050
3	1	2.7	0.15	0.075

\* Figures are based on a switch using standard 25 cams and with Symbol A contacts as noted in Table 2.

**TABLE 2 - basic switch data**

Symbol A	Symbol B	Symbol C
S.P.D.T.	D.P.D.T.	S.P.D.T.
 <p><b>Ratings</b> 125V-15A., A.C. 1/2Amp. D.C. 250V-15A., A.C. 1/4 Amp. D.C. 460V-15A., A.C.</p>	 <p><b>Ratings</b> 125-250V .A.C. 10Amp. D.C. 125 - V.D.C 1/2 Amp. 250 - V.D.C. 1/4Amp.</p>	 <p><b>Ratings</b> 125-250 V.A.C. 10 Amp.. 30 - V.D.C. 10 Amp.</p>

**Special Cams\***

Cam ** Part No.	Period for which switch contacts are opened or closed
S-55-A Standard	25° or 335°
S-68-A Special	540° or 306°
S-84-A Special	75° or 285°
S-69-A Special	90° or 270°
S-85-A Special	105° or 255°
S-86-A Special	135° or 225°
S-87-A Special	150° or 210°
S-70-A Special	180°
S-71-A Special	240° or 120°
S-127-A Special	360° Blank Cam

\*Special cams not listed, can be furnished on special order. When ordering, please specify cam angle.



# Heavy-Duty Dimensions

## SPUR GEAR TYPE — NEMA 1 & 12

DWG. NO. D-34-C

Input Shaft Has Snap Ring Grooves For Sect. 3001 Adjustable Coupling

**NOTE —**  
Approximate dimensions — not for construction unless certified.  
Shipping weight 2 lb 8 oz.

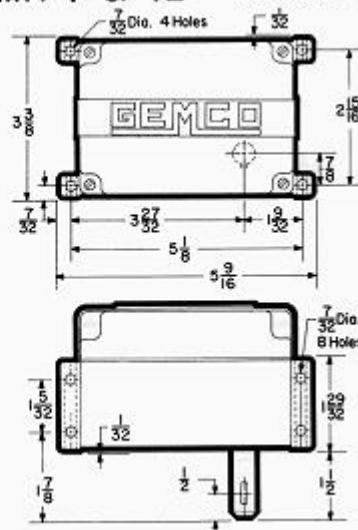
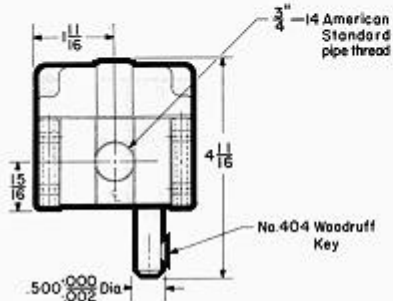

## SPUR GEAR TYPE — NEMA 4 & 7

DWG. NO. D-35-C

**NOTE —**  
Approximate dimensions — not for construction unless certified.  
Approximate shipping weight 4 lb 12 oz.

UNIT	X HEIGHT
NEMA 4	4 1/16
NEMA 7	4 2/32

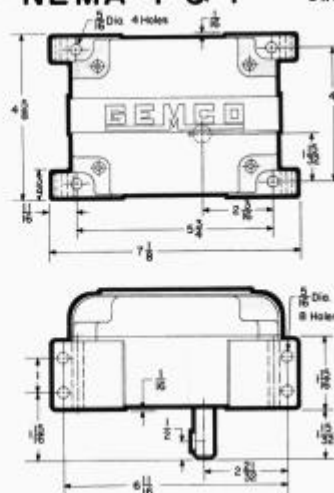
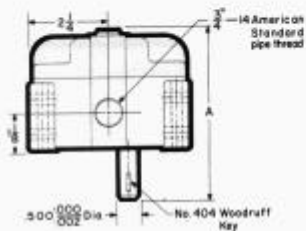

**Application:**

Ruggedly built, GEMCO'S heavyduty Rotary Limit Switches have gained wide acceptance on installations such as mechanical press ram adjustments, press extractors and shuttles which require dependable trouble free performance. These installations require a limit switch that will withstand rapid starting and stopping, shock, vibration and still successfully control the end or intermediate limits of such devices. Because of these demands and the high reliability required, GEMCO'S heavy-duty Rotary Limit Switch far exceeds any on the market.

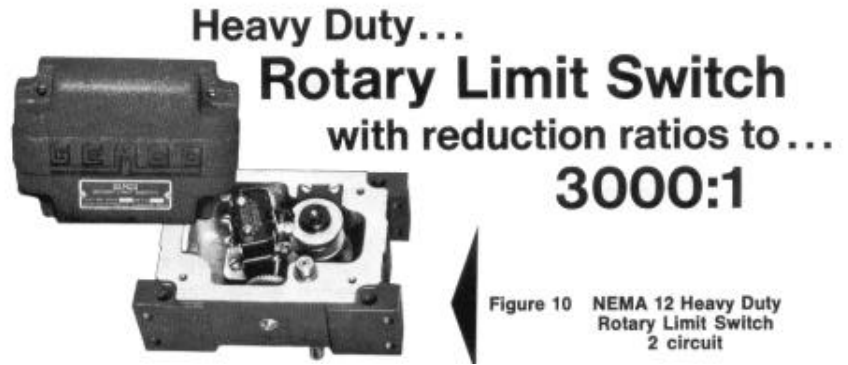







**Cams**

The input shaft (includes Woodruff Key) drives a bronze gear which rotates the cam block. The cam block houses independently adjustable cams that actuate the precision type snap action switches.

**Input Speed**

Maximum rated speed of the input Input Speed shaft is 1800 RPM; can be rotated clockwise or counterclockwise.

 Dwg. No. D-96-C	<b>Reduction Ratios</b>	<b>Two Circuit S.P.D.T. - Symbol A*</b> 	<b>Two Circuit D.P.D.T. - Symbol B*</b> 	<b>Three Circuit S.P.D.T. - Symbol C*</b> 	<b>Four Circuit S.P.D.T. - Symbol C*</b> 
		<b>Catalog No.</b>	<b>Catalog No.</b>	<b>Catalog No.</b>	<b>Catalog No.</b>
 Dwg. No. D-85-C	5:1	2000-2000	2000-2006	2000-2012	2000-2018
	7.5:1	2000-2001	2000-2007	2000-2013	2000-2019
	10:1	2000-2002	2000-2008	2000-2014	2000-2020
	15:1	2000-2003	2000-2009	2000-2015	2000-2021
	20:1	2000-2004	2000-2010	2000-2016	2000-2022
	30:1	2000-2005	2000-2011	2000-2017	2000-2023
	125:1	2000-2024	2000-2039	2000-2054	2000-2069
	156.25:1	2000-2025	2000-2040	2000-2055	2000-2070
	187.5:1	2000-2026	2000-2041	2000-2056	2000-2071
	250:1	2000-2027	2000-2042	2000-2057	2000-2072
	312.5:1	2000-2028	2000-2043	2000-2058	2000-2073
	375:1	2000-2029	2000-2044	2000-2059	2000-2074
	500:1	2000-2030	2000-2045	2000-2060	2000-2075
	625:1	2000-2031	2000-2046	2000-2061	2000-2076
750:1	2000-2032	2000-2047	2000-2062	2000-2077	
1000:1	2000-2033	2000-2048	2000-2063	2000-2078	
1250:1	2000-2034	2000-2049	2000-2064	2000-2079	
1500:1	2000-2035	2000-2050	2000-2065	2000-2080	
2000:1	2000-2036	2000-2051	2000-2066	2000-2081	
2500:1	2000-2037	2000-2052	2000-2067	2000-2082	
3000:1	2000-2038	2000-2053	2000-2068	2000-2083	

\* For switch capacities, see page 13  
For Cast Iron or Bronze Enclosure Contact Factory.

# Heavy-Duty Dimensions

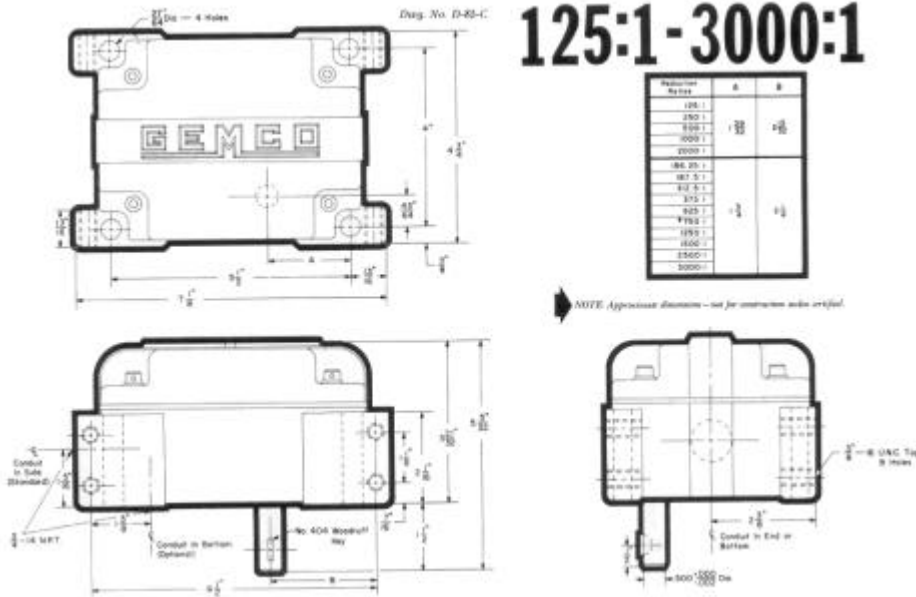
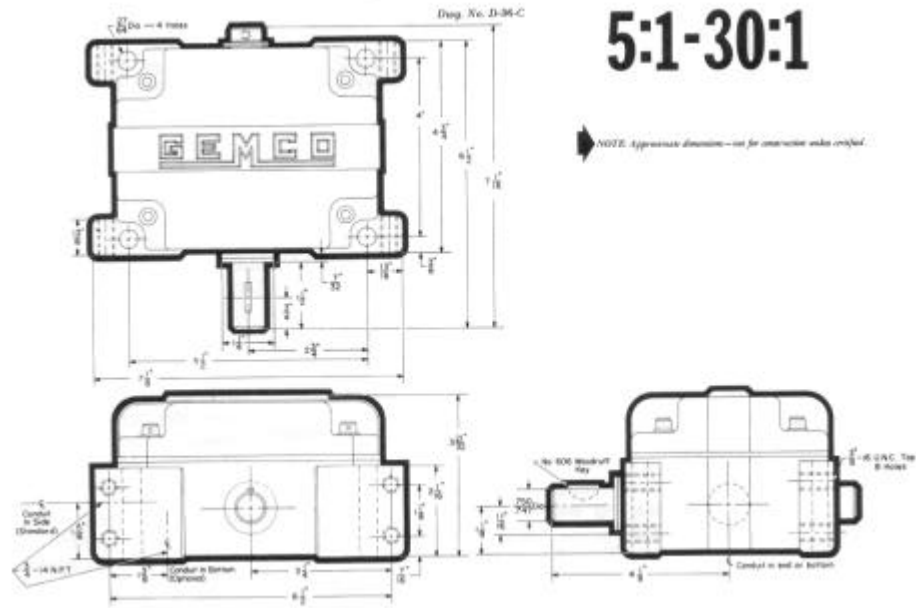

## General Purpose Rotary Limit Switches

### Featuring:

- S.P.D.T. or D.P.D.T. Industrial Duty Switches With Isolated Contacts
- Ease of Wiring With Direct Access To All Switch Terminals
- Gear Ratios From 5:1 to 1080:1
- Positive, Independent Cam Settings
- Rugged Duty Die Cast Enclosures
- Large Cover Openings For Ease of Wiring
- NEMA 4 & 5 Oiltight - Watertight - Dusttight

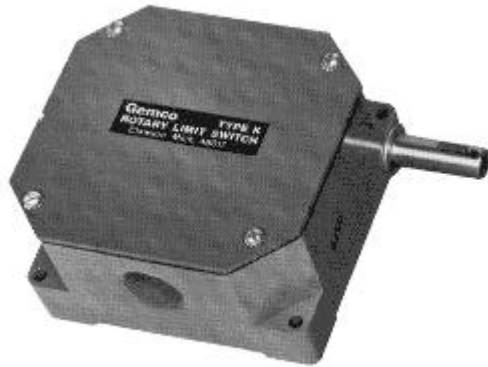

2 CIRCUIT

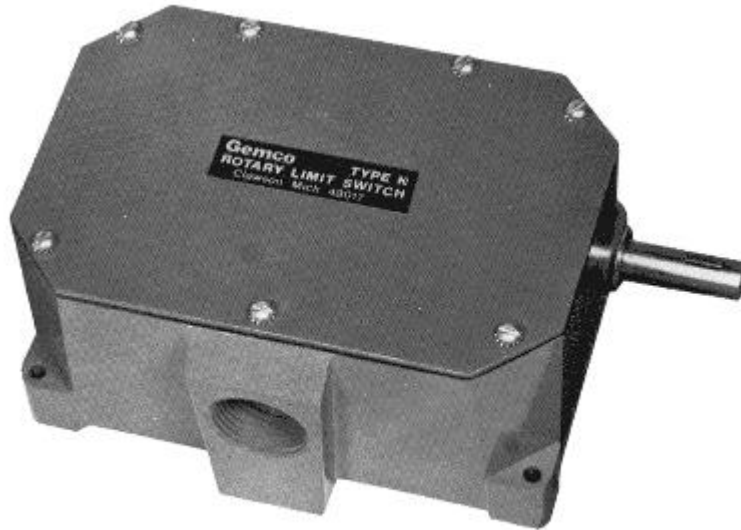

4 CIRCUIT

# TWO (2) CIRCUIT ROTARY LIMIT SWITCH CATALOG NUMBERING SYSTEM

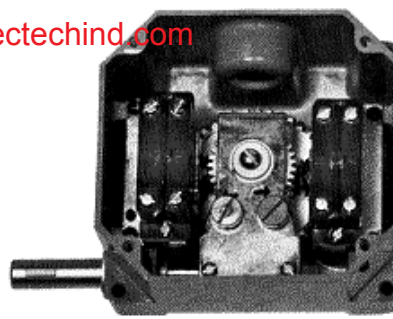

**2006** — **402** — **L** — **5** — **A**

**CATALOG SECTION**

Two (2) Circuit  
NEMA 4 Enclosure

CROSS REFERENCE 2 CIRCUIT ROTARY LIMIT SWITCH	
CUTLER HAMMER PART NO.	GEMCO PART NO.
10316H-155-1	2006-402-L-120-A
10316H-156-1	2006-402-L-60-A
10316H-157-1	2006-402-L-40-A
10316H-167-1	2006-402-L-357-A
10316H-169-1	2006-402-L-1080-A
10316H-179-1	2006-402-R-120-A
10316H-180-1	2006-402-R-60-A
10316H-181-1	2006-402-R-40-A
10316H-1016-1	2006-402-L-10-A
10316H-1017-1	2006-402-L-20-A
10316H-1018-1	2006-402-R-10-A
10316H-1019-1	2006-402-R-20-A
10316H-4556-1	2006-402-L-5-A
10316H-4557-1	2006-402-L-30-A
10316H-4559-1	2006-402-L-80-A
10316H-4560-1	2006-402-R-5-A
10316H-4561-1	2006-402-R-30-A
10316H-4563-1	2006-402-R-80-A
10316H-4591-1	2006-402-R-357-A
10316H-4595-1	2006-402-R-1080-A
10316H-4599-1	2006-402-L-270-A
10316H-4606-1	2006-402-R-270-A

SWITCH TYPE	
<b>A</b>	All S.P.D.T.
<b>B</b>	1-D.P.D.T., Balance S.P.D.T.
<b>C</b>	2-D.P.D.T.,
<b>R</b>	1950-1408 (Quick Reset)

All Switches have Isolated Contacts  
S.P.D.T. 1 NO—1 NC Contacts  
D.P.D.T. 2 NO—2 NC Contacts

RATIO	
5	5:1
10	10:1
20	20:1
30	30:1
40	40:1
60	60:1
80	80:1
120	120:1
270	270:1
357	357:1
1080	1080:1

**SHAFT EXTENSION**  
**L\*** Left Hd. Shaft Ext.  
**R** Right Hd. Shaft Ext.  
 \* Available from stock

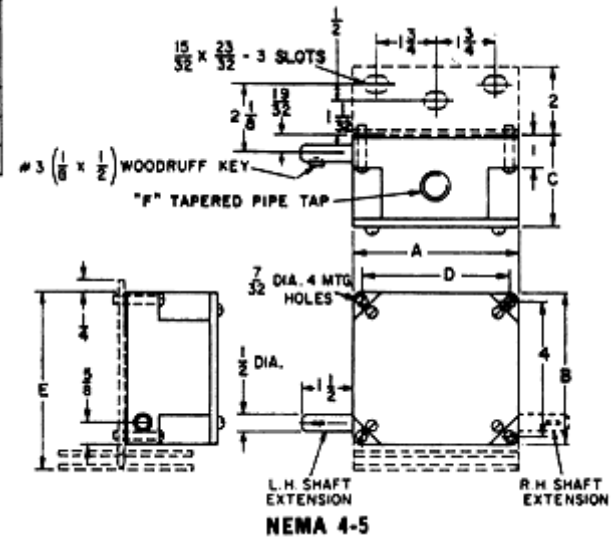

### "L" SHAPE BRACKET

When "L" Shape Bracket is purchased, use

CATALOG NUMBER	
C-6131-B	(2 circuit unit)
C-6132-B	(4 circuit unit)

Circuits	Dimensions in inches					Lbs. Boxed
	A	B	C	D	E	
2 Circuit Enclosure	4 7/8	4 1/2	2 5/8	4 3/8	5 1/4	3
4 Circuit Enclosure	6 7/8	6 1/2	3 3/8	6 3/8	5 7/32	4 1/2

① Includes half inch hub extension.

Approximate Dimensions And Shipping Weights For 2 and 4 Circuit Units  
Left Hand Extension Shown

("L" shape mounting bracket, when purchased separately, is shown in some of the possible mounting positions by broken lines.)



### FOUR (4) CIRCUIT ROTARY LIMIT SWITCH CATALOG NUMBERING SYSTEM

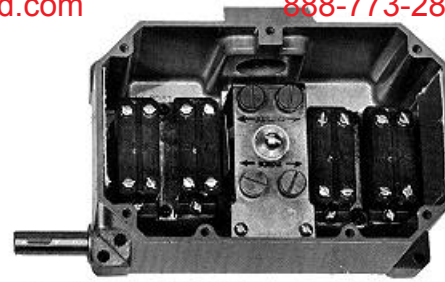
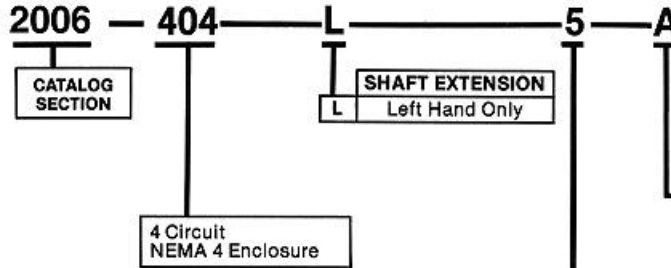

SWITCH TYPE	
A	All S.P.D.T.
B	1-D.P.D.T., Balance S.P.D.T.
C	2-D.P.D.T., Balance S.P.D.T.
D	3-D.P.D.T., Balance S.P.D.T.
E	4-D.P.D.T.,
R	Quick Reset

All Switches have Isolated Contacts  
 S.P.D.T. 1 NO—1 NC Contacts  
 D.P.D.T. 2 NO—2 NC Contacts

CROSS REFERENCE 4 CIRCUIT ROTARY LIMIT SWITCHES	
CUTLER HAMMER PART NO.	GEMCO PART NO.
10316H-158-1	2006-404-L-120-A
10316H-159-1	2006-404-L-60-A
10316H-160-1	2006-404-L-40-A
10316H-173-1	2006-404-L-1080-A
10316H-175-1	2006-404-L-357-A
10316H-1026-1	2006-404-L-10-A
10316H-1027-1	2006-404-L-20-A
10316H-4568-1	2006-404-L-5-A
10316H-4569-1	2006-404-L-30-A
10316H-4571-1	2006-404-L-80-A
10316H-4600-1	2006-404-L-270-A

RATIO	
5	5:1
10	10:1
20	20:1
30	30:1
40	40:1
60	60:1
80	80:1
120	120:1
270	270:1
357	357:1
1080	1080:1

#### SPARE SNAP SWITCHES

CUTLER HAMMER PART NUMBER	GEMCO PART NUMBER
SPDT 10316H89A	1950-1-B-A-DO
DPDT 10316H2000	1950-4-B-A-DO
Quick Reset	1950-1408



#### ELECTRICAL CONTACT RATINGS

Switch Type	Contacts	Volts	AC						Volts	DC	
			Inductive Pilot Duty 35% Power Factor				Continuous Carrying Amps	Resistive 75% Power Factor		Inductive Pilot Duty and Resistive	
			Make		Break					Make and Break Amperes Double Throw	Continuous Carrying Amps
			Amps	VA	Amps	VA					
1950-1-B-A-DO	SPDT	110	40	....	15	....	15	15	115	0.25	15
		220	20	....	10	....	15	15	230	0.1	15
		440	10	....	6	....	15	15	600	....	15
		600	8	....	5	....	15	15	....	....	....
1950-4-B-A-DO	DPDT	115	30	3450	3	345	10	10	115	0.2	10
		230	15	3450	1.5	345	10	10	230	0.1	10
		440	7.5	3450	0.75	345	10	10	600	....	10
		575	6	3450	0.6	345	10	10	....	....	....

**NOTE:** The maximum period for which the switch contacts are opened or closed during one revolution (360°) of the cam block assembly is 25° or 335°. Multiply the Rotary Limit Switch gear ratio times 25° or 335° to obtain the input shaft rotation which will yield 25° or 335° of cam block rotation.

**APPLICATION:**

The Type K Rotary Limit Switch is used in applications requiring ratios from 5:1 to 1080:1 for controlling the end and/or intermediate limits of a reciprocating or rotary motion. Two circuit and four circuit assemblies are available from stock.

The NEMA 4 & 5 enclosure provides a clean environmental condition for the industrial duty snap action switches. Where motion can be expressed in shaft rotation either through a roller chain, gear train or direct coupling, the Type K Rotary Limit Switch makes it possible to open or close up to four independent circuits at the desired angular positions.

**DESCRIPTION:**

Precision rugged duty snap action switches, combined with a wide selection of gear ratios provides reliable electrical signals as a function of the shaft rotation. No minimum speed is specified due to the snap action contacts of the switch. The cam settings and the switch wiring can be easily accomplished through the full size cover.

With the two circuit assembly, either a left hand or right hand shaft extension can be supplied. This provides the added versatility when packaging this assembly in hard-to-get-at locations.

**Ease of Making Cam Settings**



**Easy to Wire Terminals**

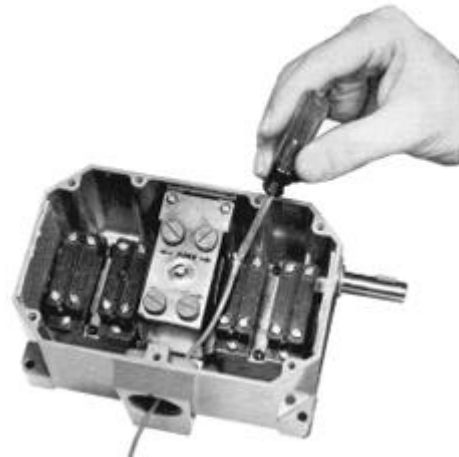

**TYPICAL APPLICATIONS ARE:**

- Door Operators
- Hoists
- Valves
- Elevating Jack Mechanisms
- Tapping Heads
- Packaging
- Machinery
- Conveyors
- Index Tables
- Material Handling Equipment
- Reciprocating Linear Actuators
- Dampers
- End Limits on Machine Tool Lead Screws
- Shuttles

**Industrial Duty Switches With Isolated Contacts**

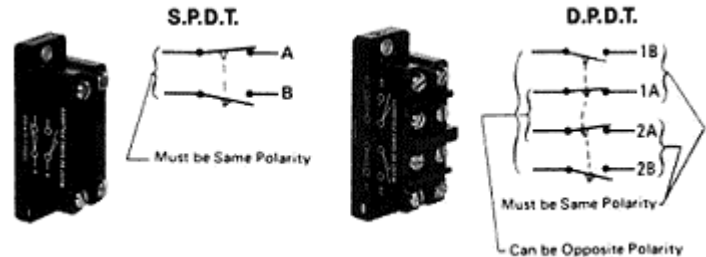

Contact positions shown are when cams ARE NOT actuating levers.

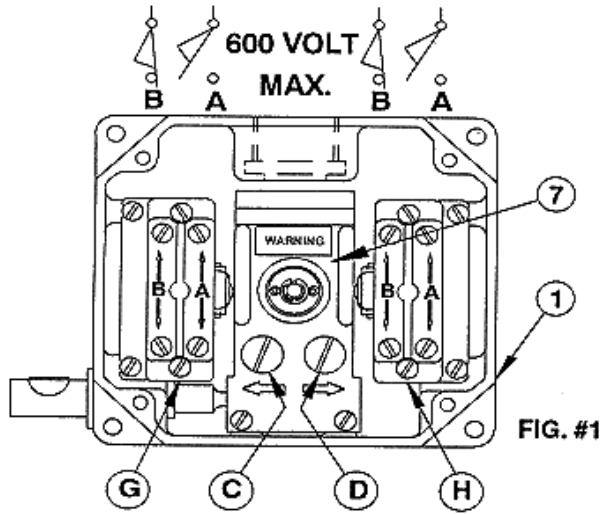

Shaft to Cam Ratio	Turns of Input Shaft			
	Maximum	Minimum	Over Travel	To Reset
5:1	4	1/8	1/8	1/16
10:1	8-1/2	1/4	1/4	1/8
20:1	17	1/2	1/2	1/4
30:1	26	1	3/4	3/8
40:1	35	1	1	1/2
60:1	53	2	2	3/4
80:1	72	2-1/2	2-1/2	1
120:1	108	3	3	1-1/2

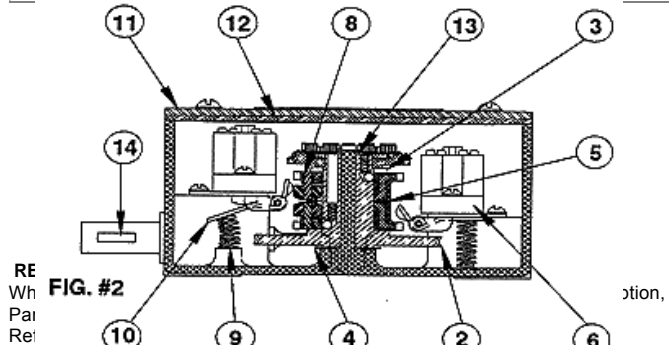

**DESCRIPTION**

This rotary limit switch is designed to control the limits of travel of rotating reversing equipment. The limit switch input shaft is connected to a worm gear. Adjustable self lubricating nylon roller cams are concentrically mounted to the worm gear. These adjustable cams actuate the precision limit switches by utilizing a lever assembly.

**INSTALLATION**

This limit switch may be mounted in any convenient position. When installed this limit switch will provide long life with a minimum amount of service maintenance.

**The following recommendations will prove helpful.**

1. Install the limit switch so that the shaft load will not exceed (5) live pounds.
2. A flexible coupling is recommended for all installation other than gear drive application.
3. Coupling should be employed in a manner that results in a minimum of thrust loading on the shaft. If switches are mounted with the shaft up or down, some additional thrust loading resulting from the weight of the shaft plus a very light coupling is permissible.
4. Whenever possible, a separate support bearing for the drive sprocket should be used.
5. Permissible speed of the input shaft 2000 R.P.M.

**LUBRICATION**

This limit switch was lubricated at the factory and should not require lubrication for the life of the switch.

**ADJUSTMENT**

Refer to figure 1. The electrical switch units "G" and "H" are shown with the contact positions assumed when the cams are not actuating the switch units.

When the cam rotates and actuates the switch, the "B" (closed) contact opens and the "A" (open) contact closes. Each precision switch has (1) one independent adjustable cam.

**TO ADJUST SWITCH "G"**

1. Loosen Red Set Screw
2. Turn "D" to Trip "H"
3. Tighten Green Set Screw

**TO ADJUST SWITCH "H"**

1. Loosen Blue Set Screw
2. Turn "C" to Trip "G"
3. Tighten Yellow Set Screw

**WARNING:**  
 LOOSEN CAM SET SCREW BEFORE ADJUSTING OR DAMAGE OF CAMS WILL OCCUR

ITEM	DESCRIPTION	PART NUMBER	QTY.
1	Case and Shaft assembly		1
	5:1 Ratio	PSD-0092400-DN	....
	10:1 Ratio	PSD-0092500-DN	....
	20:1 Ratio	PSD-0092600-DN	....
	30:1 Ratio	PSD-0092700-DN	....
	40:1 Ratio	PSD-0092800-DN	....
	60:1 Ratio	PSD-0092900-DN	....
	80:1 Ratio	PSD-0093000-DN	....
2	Cam block & Worm Gear assy.		1
	5:1 Ratio	PSD-0093500-DN	....
	10:1 Ratio	PSD-0093600-DN	....
	20:1 Ratio	PSD-0093700-DN	....
	30:1 Ratio	PSD-0093800-DN	....
	40:1 Ratio	PSD-0093900-DN	....
	60:1 Ratio	PSD-0094000-DN	....
	80:1 Ratio	PSD-0094100-DN	....
3	Shim Cam Block (.080 THK.)	PS-0003300-A	1
	Shim Cam Block (.020 THK.)	PS-0000800-A	1
	Shim Cam Block (.016 THK.)	PS-0003200-A	3
6	Limit Switch Standard S.P.D.T.	1950-1-B-A-DO	4
	Optional D.P.D.T.	1950-4-B-A-DO	....
7	Optional S.M.S.B.	1950-1408	....
	Adjusting Bracket Assembly	PSD-0024700-B	1
8	Gear and Roller Assembly	PSD-00904-00-A	4
9	Spring, Compression	PM-001 8000-A	4
10	Lever Assembly	PSD-0024500-A	2
11	Cover	PC-0069200-A	1
12	Cover Gasket	PS-0001 000-A	1
13	Spacer Center Post	M-0073000-A	1
14	Woodruff Key (#404)	04-56401 9-DN	1

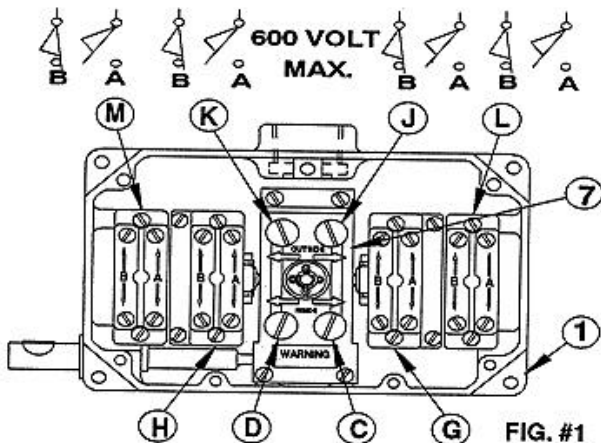

**DESCRIPTION**

This rotary limit switch is designed to control the limits of travel of rotating reversing equipment. The limit switch input shaft is connected to a worm gear. Adjustable self-lubricating nylon roller cams are concentrically mounted to the worm gear. These adjustable cams actuate the precision limit switches by utilizing a lever assembly.

**INSTALLATION**

This limit switch maybe mounted in any convenient position. When installed this limit switch will provide long life with a minimum amount of service maintenance.

The following recommendations will prove helpful.

1. Install the limit switch so that the shaft load will not exceed (5) live pounds.
2. A flexible coupling is recommended for all installation other than gear drive application.
3. Coupling should be employed in a manner that results in a minimum of thrust loading on the shaft. If switches are mounted with the shaft up or down, some additional thrust loading resulting from the weight of the shaft plus a very light coupling is permissible.
4. Whenever possible, a separate support bearing for the drive sprocket should be used.
5. Permissible speed of the input shaft 2000 R.P.M.

**LUBRICATION**

This limit switch was lubricated at the factory and should not require lubrication for the life of the switch.

**ADJUSTMENT**

Refer to figure 1. The electrical switch units "G", "H", "L" AND "M" are shown with the contact positions assumed when the cams ARE NOT actuating the switch units.

When the cam rotates and actuates the switch, the "B" (closed) contact opens and the "A" (open) contact closes. Each precision switch has (1) one independent adjustable cam.

**TO ADJUST SWITCH "M"**

1. Loosen Red Set Screw
2. Turn "K" to Trip "M"
3. Tighten Red Set Screw

**TO ADJUST SWITCH "L"**

1. Loosen Blue Set Screw
2. Turn "J" to Trip "L"
3. Tighten Blue Set Screw

**TO ADJUST SWITCH "H"**

1. Loosen Green Set Screw
2. Turn "D" to Trip "H"
3. Tighten Green Set Screw

**TO ADJUST SWITCH "G"**

1. Loosen Yellow Set Screw
2. Turn "C" to Trip "G"
3. Tighten Yellow Set Screw

**WARNING: LOOSEN CAM SET SCREW BEFORE ADJUSTING OR DAMAGE OF CAMS WILL OCCUR**

Nominal Input Shaft to Cam Ratio	Turns of Input Shaft			
	Maximum	Minimum	Over Travel	To Reset
5:1	4	1/8	1/8	1/16
10:1	8-1/2	1/4	1/4	1/8
20:1	17	1/2	1/2	1/4
30:1	26	1	3/4	3/8
40:1	35	1	1	1/2
60:1	53	2	2	3/4
80:1	72	2-1/2	2-1/2	1
120:1	108	3	3	1-1/2

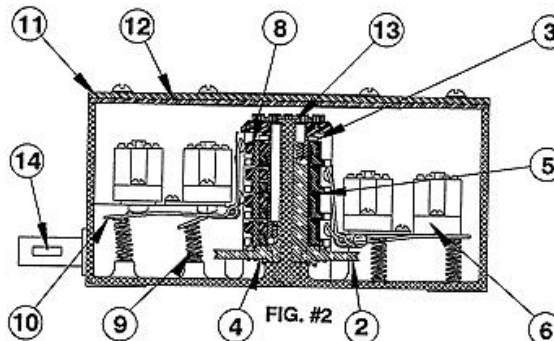

**RENEWAL PARTS**

When ordering Renewal Parts give this form No. PF-047, Item No., Description, Part No., Quantity, and the Complete Unit Number stamped on the label. Reference FIG. #1 and FIG. #2 above.

ITEM	DESCRIPTION	PART NUMBER	QTY.
1	Case and Shaft assembly		1
	5:1 Ratio	PSD-0092400-DN	....
	10:1 Ratio	PSD-0092500-DN	....
	20:1 Ratio	PSD-0092600-DN	....
	30:1 Ratio	PSD-0092700-DN	....
	40:1 Ratio	PSD-0092800-DN	....
	60:1 Ratio	PSD-0092900-DN	....
	80:1 Ratio	PSD-0093000-DN	....
2	120:1 Ratio	PSD-0093100-DN	....
	Cam block & Worm Gear assy.		1
	5:1 Ratio	PSD-0093500-DN	....
	10:1 Ratio	PSD-0093600-DN	....
	20:1 Ratio	PSD-0093700-DN	....
	30:1 Ratio	PSD-0093800-DN	....
	40:1 Ratio	PSD-0093900-DN	....
	60:1 Ratio	PSD-0094000-DN	....
3	80:1 Ratio	PSD-0094100-DN	....
	120:1 Ratio	PSD-0094200-DN	....
3	Shim Cam Block (.080 THK.)	PS-0003300-A	1
4	Shim Cam Block (.020 THK.)	PSD-000800-A	1
5	Shim Cam Block (.016 THK.)	PS-0003200-A	3
6	Limit Switch Standard S.P.D.T.	1950-1-B-A-DO	4
	Optional D.P.D.T.	1950-4-B-A-DO	....
7	Optional S.M.S.B.	1950-1408	....
	Adjusting Bracket Assembly	PSD-0024700-B	1
8	Gear and Roller Assembly	PSD-00904-00-A	4
9	Spring, Compression	PM-001 8000-A	4
10	Lever Assembly	PSD-0024500-A	2
11	Cover	PC-0069200-A	1
12	Cover Gasket	PS-0001 000-A	1
13	Spacer Center Post	M-0073000-A	1
14	Woodruff Key (#404)	04-56401 9-DN	1



# Special Gemco Rotary Limit Switches To Meet Your Specific Applications



Two Circuit Rotary Limit Switch with a Special Mounting Bracket and Integral Right Angle Worm Gear for Mounting in a Power Jack.

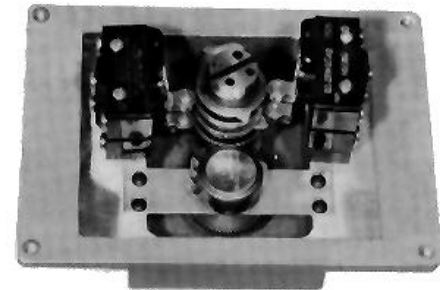

Special NEMA 4 Four Circuit Rotary Limit Switch with a Potentiometer for mounting on a rotary valve.

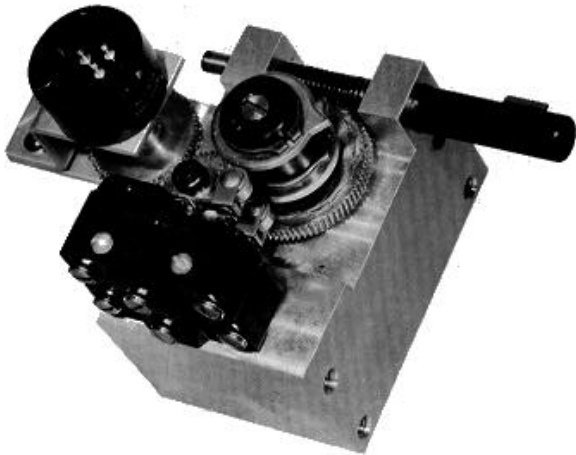

Special Two Circuit Open Type Rotary Limit Switch with a Single Turn Potentiometer.



Special Three Circuit Rotary Limit Switch used on a Mobile Man Lift.





### **WORM GEAR TYPE**

Ratios from 5:1 to 5333.3:1

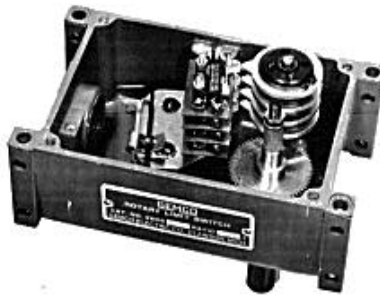

### **SPUR GEAR TYPE**

Ratios from .5:1 to 3:1

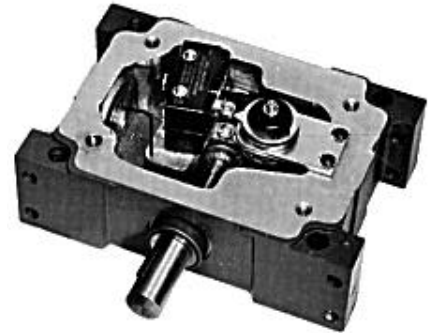

### **HEAVY DUTY TYPE**

Ratios from 5:1 to 3000:1

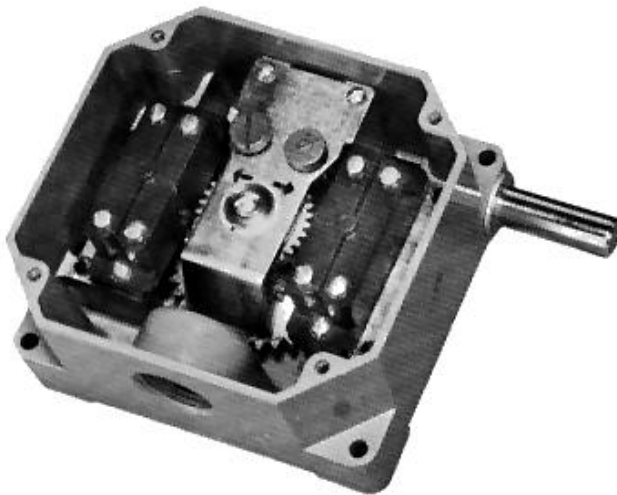

### **2 CIRCUIT**

#### **WORM GEAR TYPE**

Ratios from 5:1 to 1080:1



### **4 CIRCUIT**

#### **WORM GEAR TYPE**

Ratios from 5:1 to 1080:1